



experience and technology innovation for clean air



PNEUMATIC CONVEYING SYSTEMS FOR PELLET & BIOMASS STORAGE SILO SOLUTIONS CLEANING AND ASH-CLEANER

PRODUCTS LIST 2015

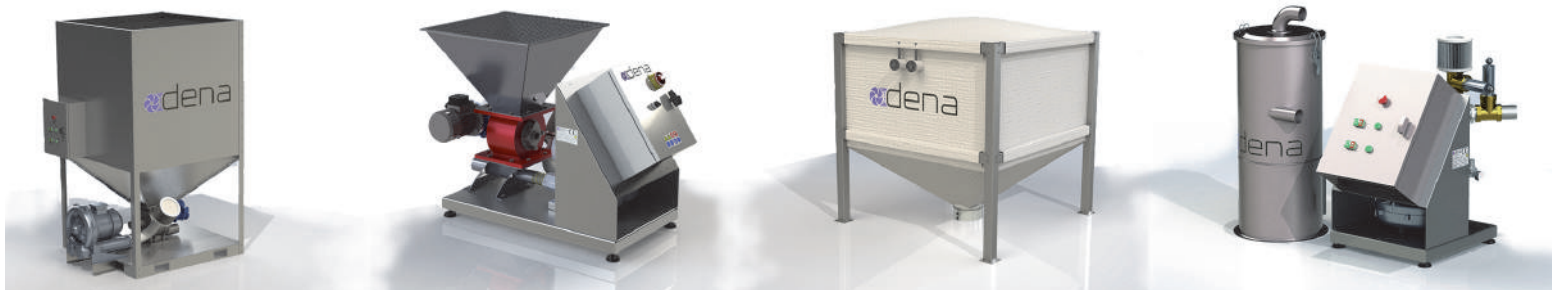

DENA ASPIRAZIONI INDUSTRIALI Pneumatic conveying systems

Thanks to 40 years of experience in industrial suction plants for clean air our Research and Development department has put on the market our new series of pneumatic conveying systems suitable for granular biomass to feed any kind of home and industrial heating system.

Employing experience combined with high standards of technology Dena has always dealt with project engineering in combination with renewable energy and consequently respect for the environment.

Our pneumatic conveying systems and storage silo solutions offer numerous advantages over traditional fuel feeding solutions as indicated in the catalogue.

A great advantage is the possibility to exploit the return air of the turbine that is conveyed into the suction probe, so that it creates gradual and continuous distribution of pellet or other biomass fuel into the intake circuit.

Moreover it is possible to combine the WX series with the new ash pre-separator in order to clean your boiler or with any other type of silo or self built storage room with flat surface too without the help of mechanical system of extraction.

Our products comply with the regulations as outlined in the European Machinery Directive obtaining the most important European Certifications.

Technology innovation, integrated solutions and comprehensive global service are the strengths of our company.

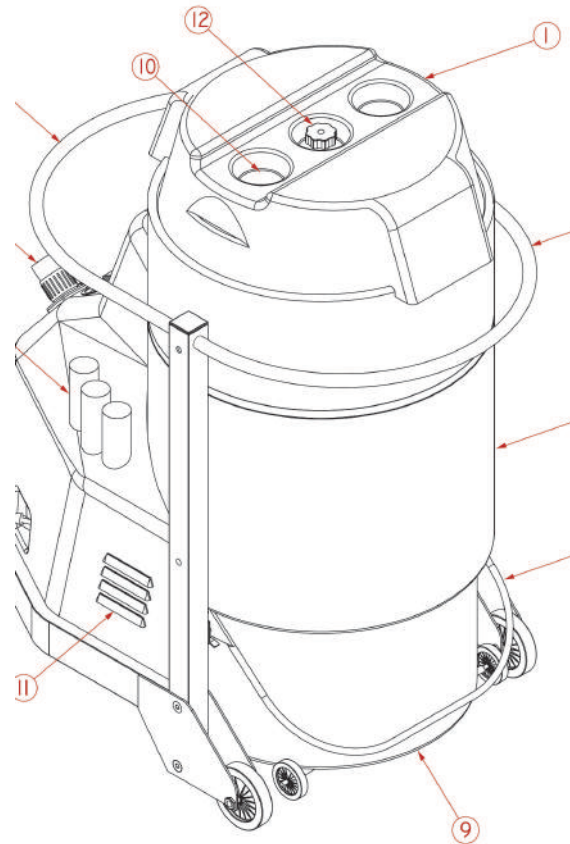

Two-One functions



two-one functions: ash-cleaner and pneumatic conveyor systems

With our WX systems you can feed and keep your boiler clean together with your storage room without breathing toxic dust.

Economical

With the WX systems you can built a storage tank made of metal, wood or a masonry room saving the costs of purchasing a storage silo

Suction conveying system

Our systems offer lots of advantages such as the possibility to connect the storage room to the boiler by means of flexible hoses covering complex distance too; without any spill of fuel. Very simple to set up.

Automatic operation

The functioning of our WX systems is completely automatic

Quick and easy installation PLUG & PLAY

Installation and set up are carried out quickly and easily

Compatible with all pellet stoves and boilers

The available versions permit the application of our systems on any kind of pellet stove and boiler and storage silo either internal or external. they can be combined with underground silo too.

Delicate treatment

The vacuum extraction system permits to convey pellet into the boiler perfectly clean and without any damage



Solution A: suction system and pellet pneumatic loading with suction probe for self-built storage room

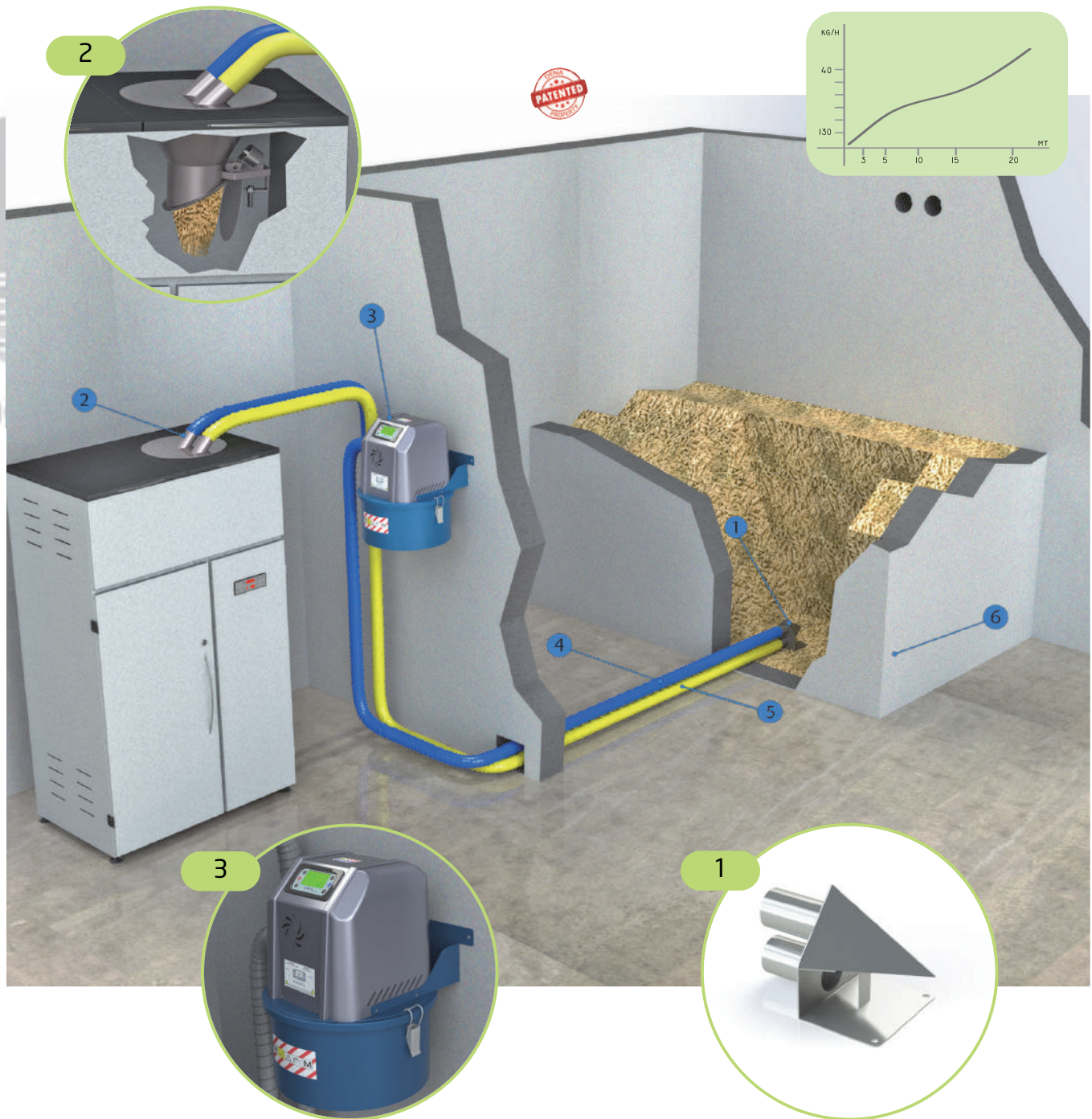

1	Suction probe	ART NO PR001
2	Discharge hopper WX10	ART NO WX1001
3	Suction motor WX11	ART NO WX1101
4	Pneumatic conveying hose for pellet	ART NO TB0001
5	Return air hose	ART NO TB0001
6	Self-built storage room	

Solution B: suction system and pellet pneumatic loading with storage silo and pre-separator for ash vacuuming

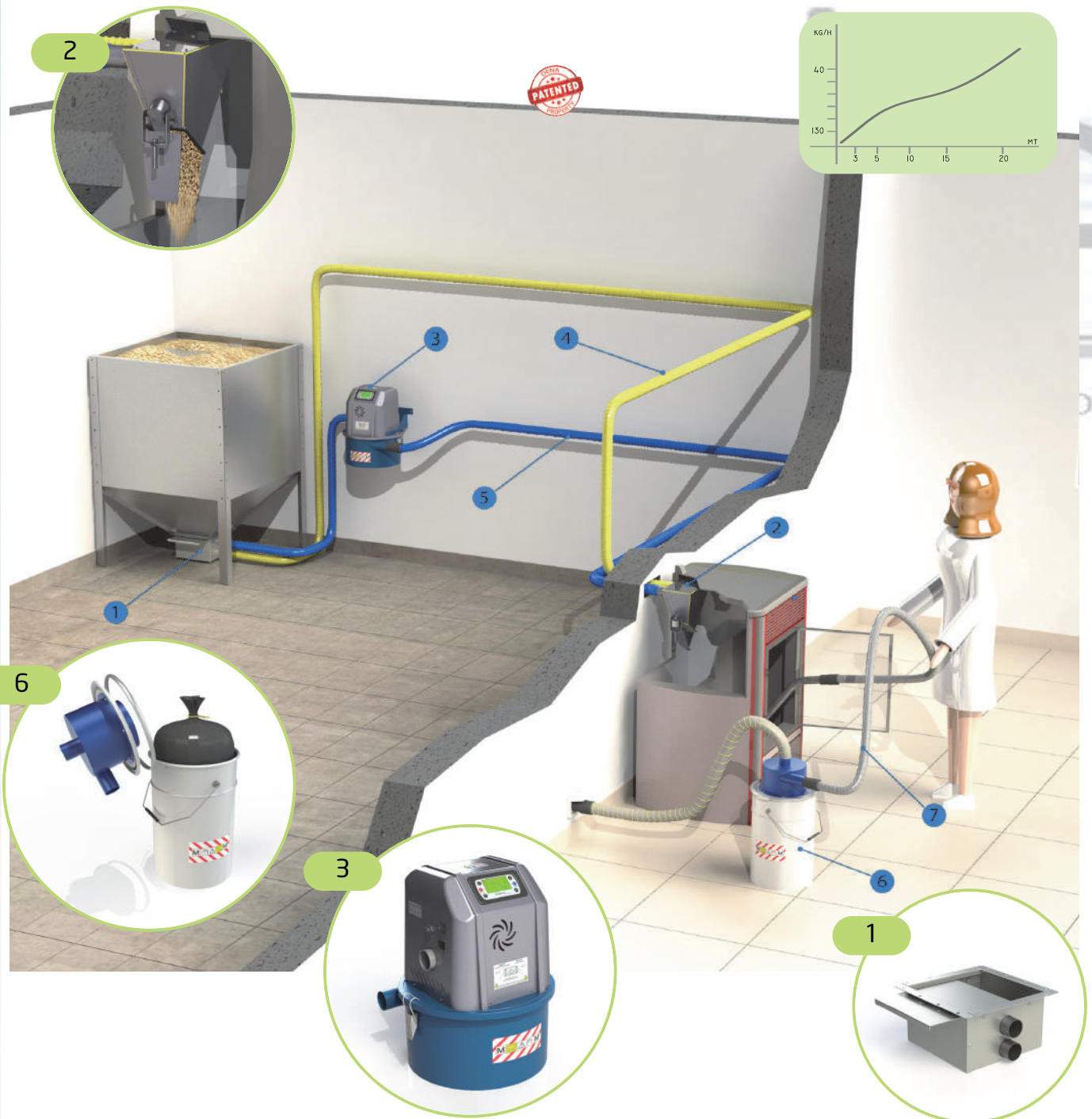

1	Suction probe	ART NO PR001
2	Discharge hopper WX10	ART NO WX1001
3	Suction motor WX11	ART NO WX1101
4	Pneumatic conveying hose for pellet	ART NO TB0001
5	Return air hose	ART NO TB0001
6	Ash preseparator with plastic bag	ART NO PRC01
7	Hose kit with handle	ART NO KTA01

Solution C: suction system and pellet pneumatic loading with three suction probes for self-built storage room



1	Suction probe	ART NO PR0001
2	Discharge hopper WX10	ART NO WX1001
3	Suction motor WX11	ART NO WX1101
4	Pneumatic conveying hose for pellet	ART NO TB0001
5	Return air hose	ART NOTB0001
6	Self-buil storage room	
7	Manual change over unit	ART NO PR0013
8	Ash-preseparator	ART NO PRC01
9	Accessory kit for air suction with noozle	ART NO KTA02

SOLUTION D: suction system and pellet pneumatic loading with four suction probes with automatic changeover unit



1	Suction probe	ART NO PR0001
2	Discharge hopper WX10	ART NO WX1001
3	Suction motor WX11	ART NO WX1101
4	Pneumatic conveying hose for pellet	ART NO TB0001
5	Return air hose	ART NO TB0001
6	Automatic changeover unit	ART NO SPAUT4
7	Hose wall plate connector	ART NO PP0004
8	Ash-preseparator	ART NO PRC01

SOLUTION E: suction system and pellet pneumatic loading for pellet stove or insert fireplace with storage silo

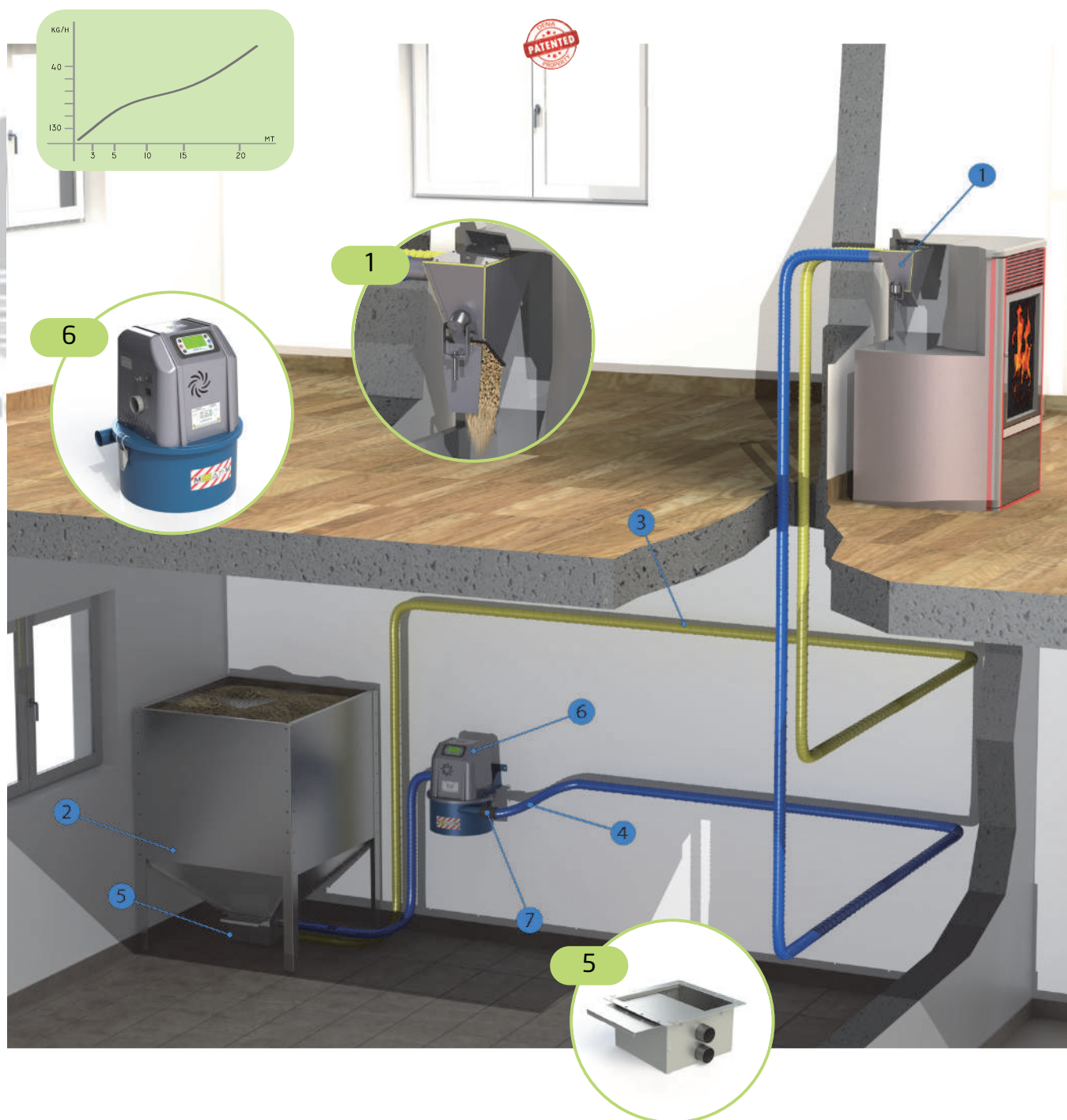

1	Discharge hopper WX5	ART NO WX5005
2	Storage silo 1 m ³	ART NO SL001M
3	Pneumatic conveying hose for pellet	ART NO TB0001
4	Return air hose	ART NO TB0001
5	Pellet extraction module	ART NO PR00ES
6	Suction motor WX11	ART NO WX1101
7	Rubber sleeve Ø50	ART NO MG50E

SOLUTION F: suction system and olive stone pomace pneumatic loading with multiple suction probes for storage room.

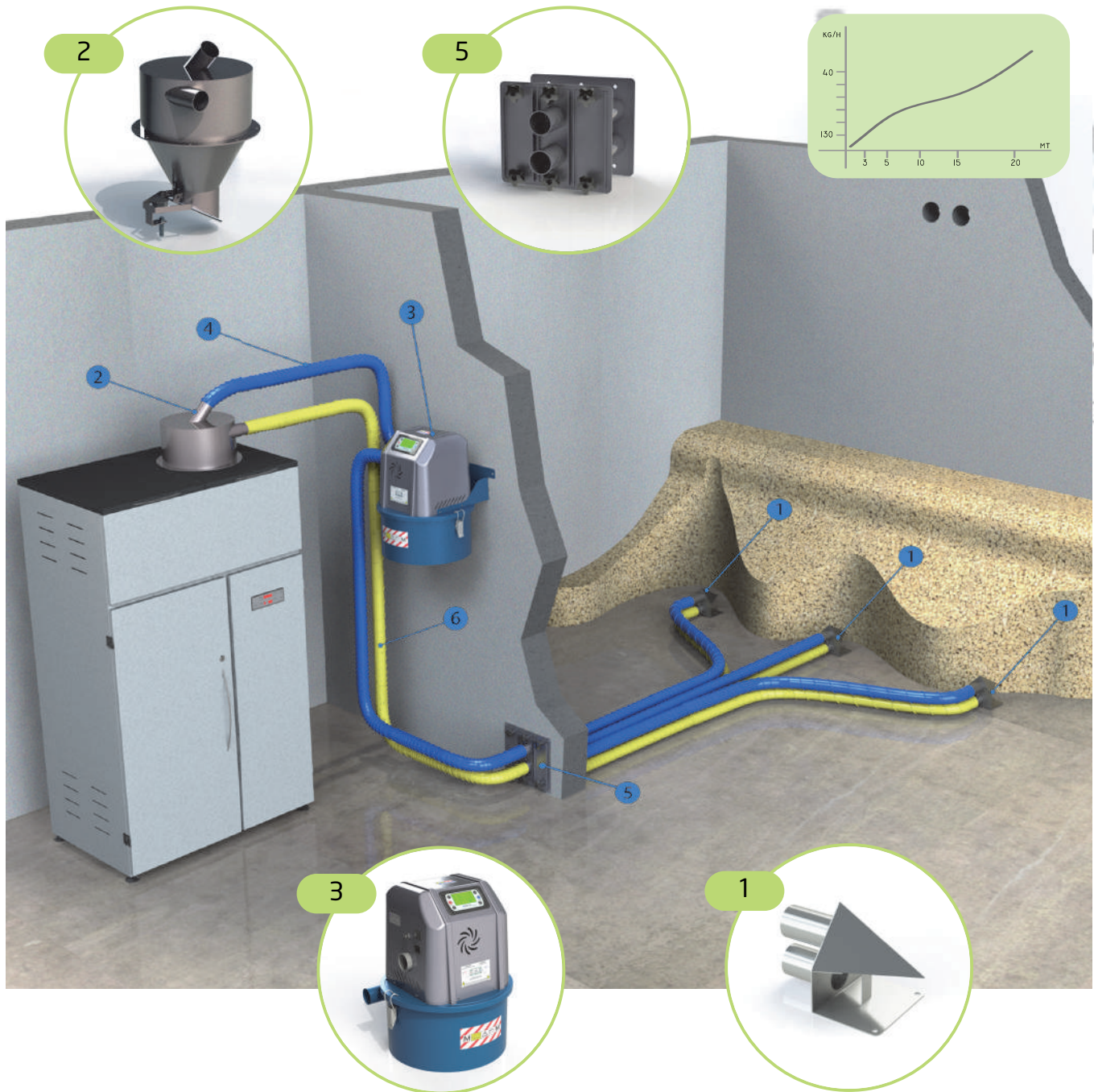

1	Suction probe	ART NO PR0001
2	Discharge hopper WX10 C	ART NO WX1011
3	Suction motor WX11	ART NO WX1101
4	Return air hose	ART NO TB0001
5	Manual change over unit	ART NO PR0013
6	Pneumatic conveying hose for pellet	ART NO TB0001



SOLUTION G: suction system and pellet pneumatic loading with suction from big-bag

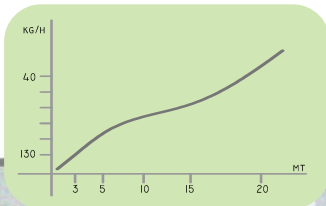

1	Big bag suction probe	ART NO PR3669
2	Pneumatic conveyor WX15	ART NO WX1015
3	Pneumatic conveying hose for pellet	ART NO TB0001
4	Return air tube	ART NO TB0001

SOLUTION H: suction system and pellet pneumatic loading from underground storage silo

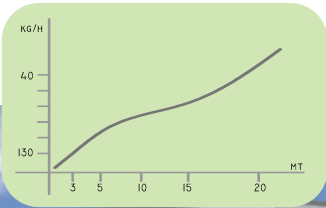

1	Pneumatic conveyor WX15	ART NO WX1015
2	Return air probe	ART NO TB0001
3	Pneumatic conveying hose for pellet	ART NO TB0001



SOLUTION I: suction system and pellet pneumatic loading from the storage silo to the burner



1	Extraction module for pellet	ART NO PR00ES
2	Discharge hopper WX10	ART NO WX1001
3	Suction motor WX11	ART NO WX1101
4	Return air hose	ART NO TB0001
5	Pneumatic conveying hose for pellet	ART NO TB0001
6	Storage silo 1 m ³	ART NO SL001M
7	Intermediate hopper for burners	ART NO WX1005
8	Rubber sleeve Ø50	ART NO MG50E

SOLUTION L: suction system and pellet pneumatic loading for considerable distance



1	Connection module extraction with screw	ART NO CE00WX
2	Hopper WX10C	ART NO WX1011
3	Peumatic conveying hose for pellet	ART NO TB0001
4	Depression hose	ART NO TB0001
5	Fixed suction base WX52	ART NO BFS52
6	Storage silo 1 m ³	ART NO SL001M
7	Ash-preseparator	ART NO PRC01
8	Fixed filtering base	ART NO BFR01
9	Hole accessory kit with noozle	ART NO KTA02
10	Rubber sleeve Ø50	ART NO MG50E

SOLUTION M: suction system and pellet pneumatic loading for industrial heating plant from fabric silo



1	Suction probe for silo SIT type	ART NO PR12ES
2	Discharge hopper WX52	ART NO WXG115
3	Pneumatic conveying hose for pellet	ART NO TB0002
4	Hose in depression	ART NO TB0002
5	Fixed suction base WX52	ART NO BFS52
6	Fabric storage silo 10 m ³	ART NO SIT10
7	Hose clamp Ø50	ART NO FS0002

SOLUTION N: Suction system and pellet pneumatic loading with centralized suction motor

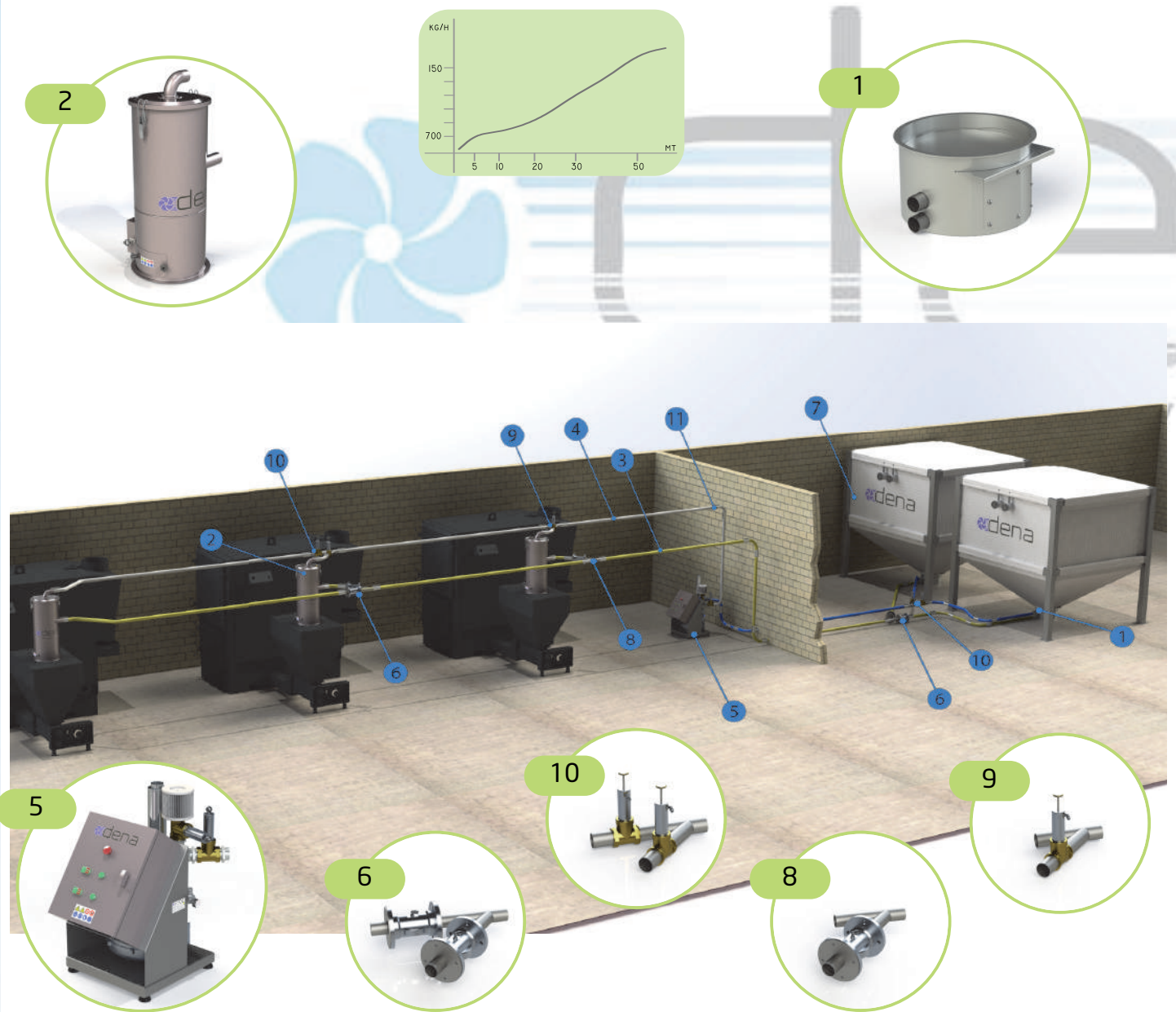

1	Suction probe for silo SIT type	ART NO PR12ES
2	Discharge hopper WX54 (with minimal level sensor)	ART NO WXG116
3	Pneumatic conveying hose for pellet	ART NO TB0002
4	Hose in depression	ART NO TB0002
5	Fixed suction base WX55 for three hoppers	ART NO BFS55x3
6	Y deviation valve 2 ways for pellet hose	ART NO VAY-P
7	Storage fabric silo 10 m ³	ART NO SIT10
8	Y deviation valve for pellet hose	ART NO VAY-P1
9	Y deviation valve for return air hose	ART NO VAY-V1
10	Y deviation valve 2 ways for return air hose	ART NO VAY-V
11	Compression clamp Ø50	ART NO FS0002



SOLUTION O: Centralized suction system and pneumatic pellet loading

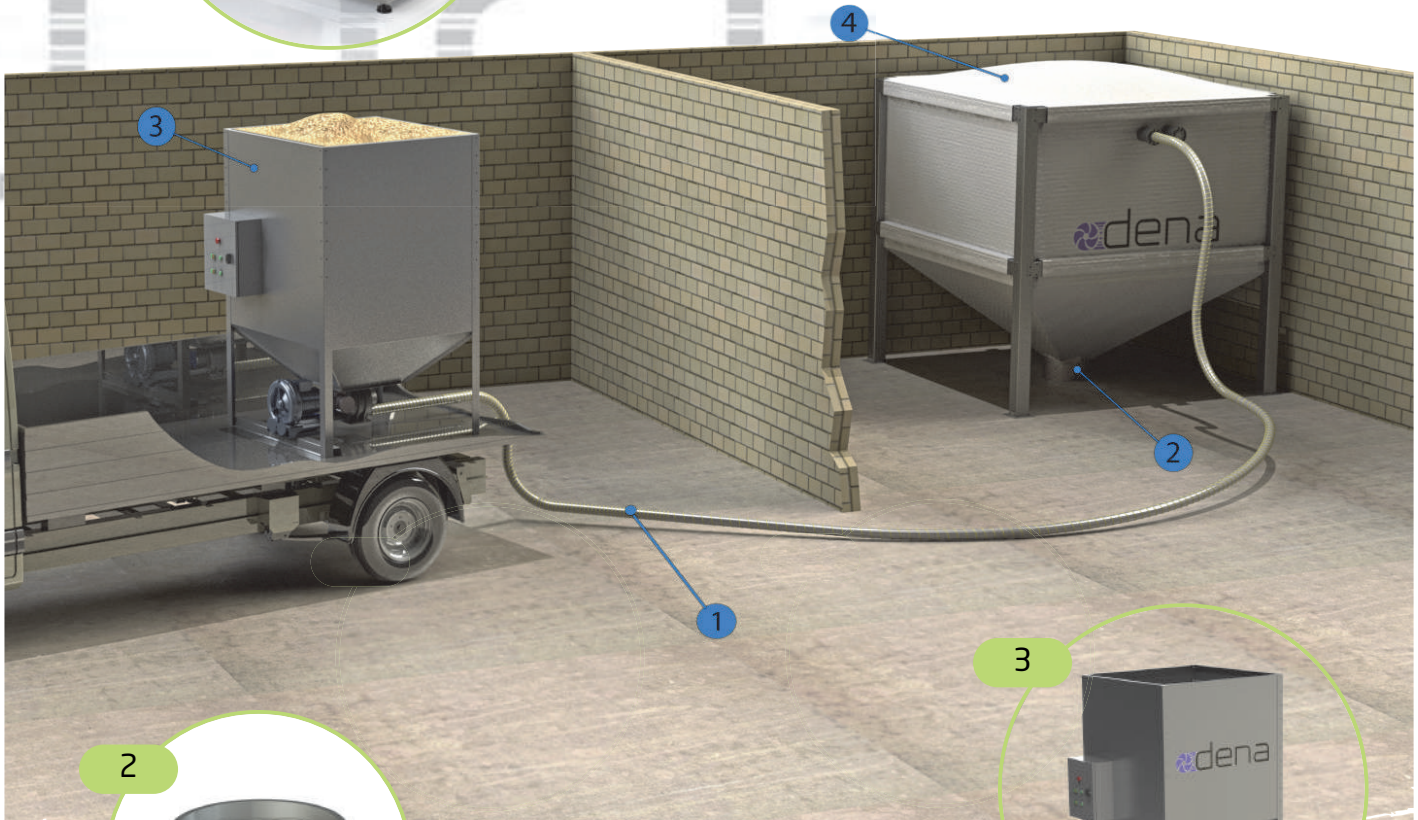
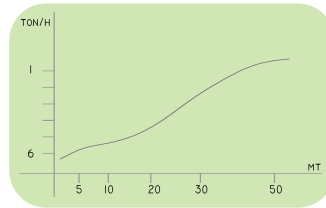

1	Pneumatic conveying hose for pellet	ART NO TB0003
2	Suction probe for silo SIT type	ART NO PR12ES
3	Mobile pneumatic conveying system	ART NO CPS/SVP
4	Fabric silo 10 m ³	ART NO SIT10

All accessories and components are Made in Italy. They are extremely versatile and can be easily assembled and combined together. Our range of products guarantees great injection distance, optimum fuel distribution and flexible set up options.





ASH-PRESEPARATOR

Our ash-preseparators can be used together with ash-cleaners and with our suction conveying systems WX. Any residue of dirt that your ash-cleaner cannot remove, can be sucked up by our pre-separator. It vacuums hygienically and simply liquids, ash, humid dirt etc, that means waste disposal without dust because of its plastic bag.

Standard equipment

- ◇ Accessory to collect dirt into the plastic bag



innovation for clean air

Model	Unit of measure	PRC	PRC15	PRC15H
capacity	lt	20	150	150
material	/	steel	steel	steel
dimensions	mm	300 x 450	550 x 950	550 x 950
IN/OUT hoses	mm	Ø 50	Ø 50	Ø 50

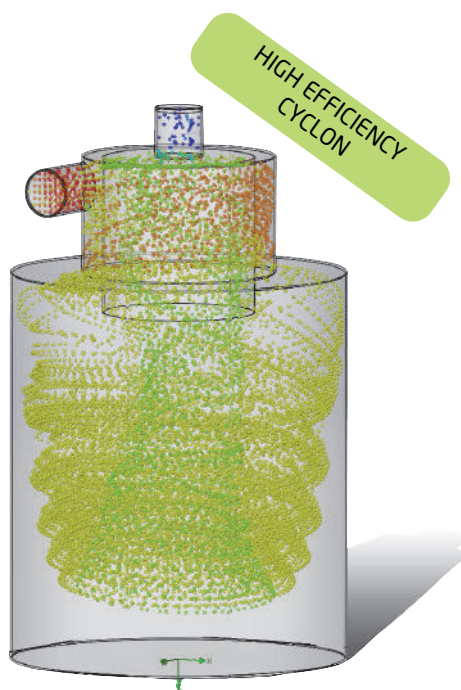
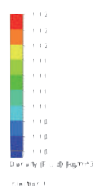

PRC15

PRC15H for incandescent ash



Accessories

	Hose kit Ø40 3mt with nozzle	ART NO
		KTA002

	Hose kit Ø40 3mt with handle	ART NO
		KTA001

	Hose kit Ø40 6mt with nozzle	ART NO
		KTA003

	Hose kit Ø40 6mt with handle	ART NO
		KTA004

	Rubber sleeve for connection hoses flex Ø50	ART NO
		MG50C

	compression clamp	ART NO
		FS0001



NEW FILTER CLEANING SYSTEM

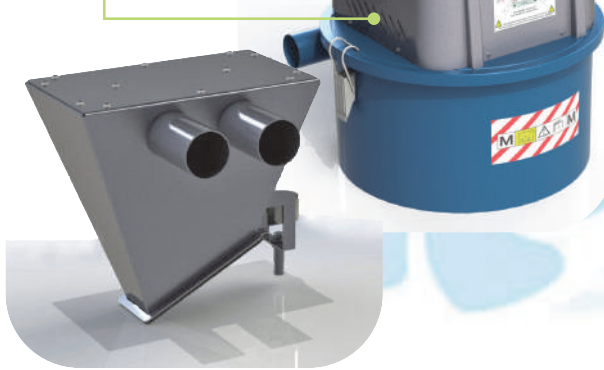

PNEUMATIC CONVEYOR WX5

The WX5 pneumatic conveyor is the ideal solution for dosing granular biomass to automate your heating system with minimal costs and maintenance. It works as ash-cleaner too.

- ⇒ IDEAL SYSTEM TO FEED BIOMASS STOVES AND INSERT FIREPLACES
- ⇒ AUTOMATIC OPERATION
- ⇒ ADAPTABLE TO ANY HEATING SYSTEM- AUTOMATIC OPERATION
- ⇒ CHRONO TIME SETTING
- ⇒ REMOTE CONTROL PER 3G/LAN

Standard equipment

- ◇ Control panel with black-lit lcd display
- ◇ Polyester cartridge filter
- ◇ level sensor
- ◇ Product exhaust valve
- ◇ Alimentation shuko cable 2 mt
- ◇ Sensor alimentation cable 10 mt

MODEL	Unit of measure	WX5
Rated electrical power	W	1500
Rated voltage	V	110/220
Rated frequency	Hz	50/60
Internal hopper capacity	lt	3
Max vacuum rate	Mbar	275
Filter cleaning system	/	Self-cleaning cartridge
Structure	Material	Steel/ ABS
Total weight	kg	20
Motor dimensions	mm	390 x 390 x H 498
IN/OUT holes	mm	Ø 50
Hopper dimensions	mm	153 x 273 x H 250

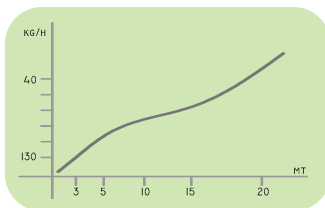
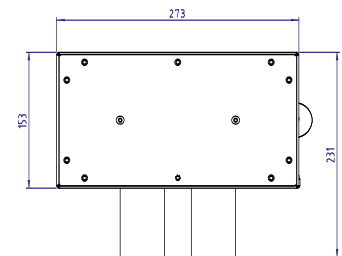
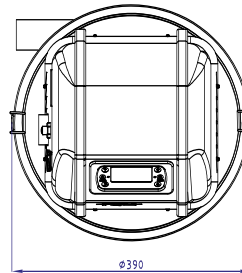
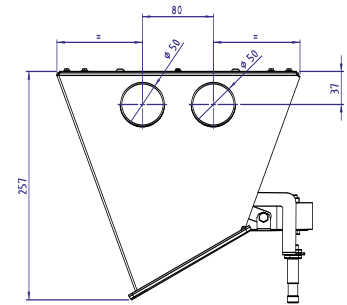
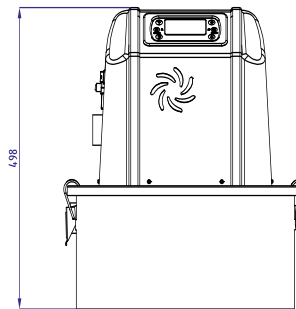

Accessories

	Rubber sleeve for hole Ø50	ART NO
		MG50E

	Sensor cable 20 mt	ART NO
		CV20

	Automatic changeover unit	ART NO
		SPAUT04

	Mini hopper WX2	ART NO°
		WX5002

	Remote control kit LAN/3G	ART NO
		KTE3G

	Compression clamp	ART NO
		FS0001



NEW CYCLON
-50% DUST



EXCLUSIVE CLEANING FILTER
SYSTEM

PNEUMATIC CONVEYOR WX10

The WX10 pneumatic conveyor is the ideal solution for dosing granular biomass to automate your heating system with minimal costs and maintenance. It works as ash-cleaner too.

- ⇒ IDEAL SYSTEM TO FEED ANY PELLET STOVE AND INSERT FIREPLACE
- ⇒ AUTOMATIC OPERATION
- ⇒ ADAPTABLE TO ANY HEATING SYSTEM
- ⇒ CHRONO TIME SETTING
- ⇒ REMOTE CONTROL PER 3G/LAN

Standard equipment

- ◇ Control panel with black-lit lcd display
- ◇ Polyester filter
- ◇ Level sensor
- ◇ Product exhaust valve
- ◇ Alimentation shuko cable 2 mt
- ◇ Sensor connection cable 10 mt

innovation for clean air

MODEL	Unit of measure	WX10
Electric rated power	W	1500
Rated voltage	V	110/220
Rated frequency	Hz	50/60
Internal hopper capacity	lt	5
Max vacuum rate	Mbar	275
Tipo di filtro	/	Self-cleaning cartridge
Structure	Material	Steel / ABS
Total Weight	kg	22
Motor Dimensions	mm	390 x 390 x H 498
IN/OUT hoses	mm	Ø 50
Hopper Dimensions	mm	Ø 280 x H 270

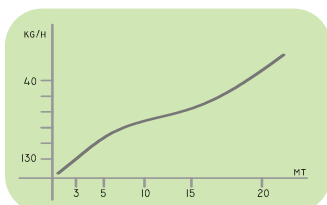
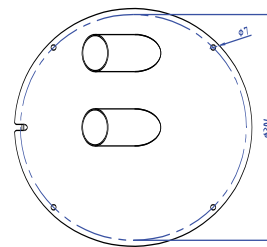
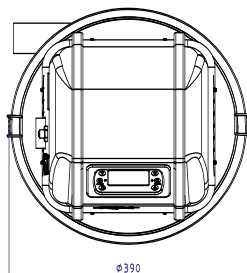
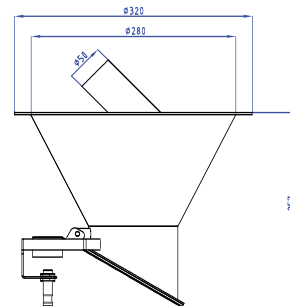
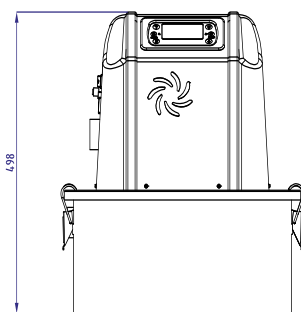

Accessories

	Suction probe	ART NO
		PR0001

	Flexible antistatic tube Ø 50 (min oder 20mt)	ART NO
		TB0001

	Ash preseparator	ART NO
		PRC01

	Hopper WX10 with motorized valve	ART NO
		WX1003

	Manual changeover unit	ART NO
		PR0013

	Intermediate hopper	ART NO
		WX1005



PNEUMATIC CONVEYOR WX10C

The WX10C pneumatic conveyor is the ideal solution for dosing granular biomass to automate your heating system with minimal costs and maintenance. It works as ash-cleaner too.

- ⇒ IDEAL SYSTEM FOR DUSTY BIOMASS
- ⇒ AUTOMATIC OPERATION
- ⇒ ADAPTABLE TO ANY HEATING SYSTEM
- ⇒ CHRONO TIME SETTING
- ⇒ REMOTE CONTROL PER 3G/LAN

Standard equipment

- ◆ Control panel with black-lit lcd display
- ◆ Polyester cartridge filter
- ◆ Level sensor
- ◆ Exhaust valve product
- ◆ Alimentation shuko cable 2 mt
- ◆ Sensor connection cable 10 mt

experience and technology in

MODEL	Unit of measure	WX10
Electrical rated power	W	1500
Rated voltage	V	110/220
Rated frequency	Hz	50/60
Internal hopper capacity	lt	6
Max vacuum rate	Mbar	275
Type of filter	/	Self-cleaning cartridge
Structure	Material	Steel / ABS
Total weight	kg	23
Motor dimensions	mm	390 x 390 x H 498
IN/OUT hoses	mm	Ø 50
Hopper dimensions	mm	Ø 280 x H 470

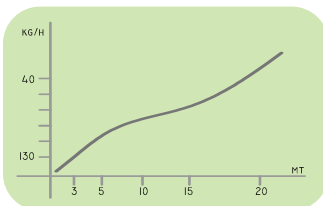
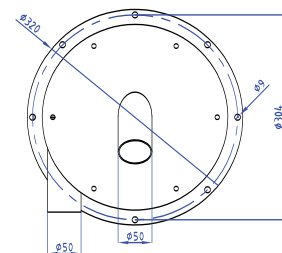
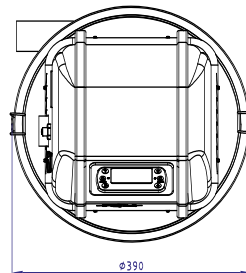
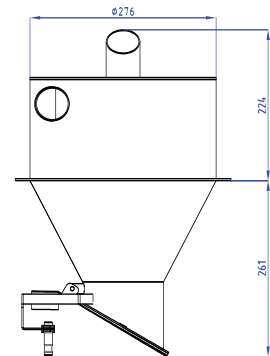
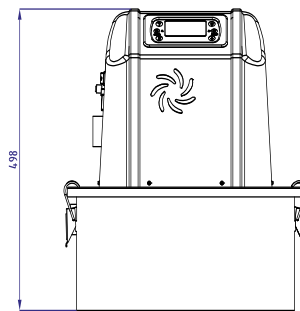

ACCESSORIES

	Rubber sleeve for hose Ø50	ART NO
		MG50E

	Sensor cable 20 mt	ART NO
		CV20

	Automatic changeover unit	ART NO
		SPAUT04

	Fluidising	ART NO
		SL0001

	Remote control kit LAN/3G	ART NO
		KTE3G

	Intermediate hopper	ART NO
		WX1005



PNEUMATIC CONVEYOR WX15

The pneumatic conveyor model WX15 is the ideal solution for dosing biomass products to automate your heating system with minimal costs and maintenance.

- ⇒ IDEAL SYSTEM TO FEED PELLET STOVES AND BOILERS
- ⇒ AUTOMATIC OPERATION
- ⇒ ADAPTABLE TO ANY HEATING SYSTEM
- ⇒ CHRONO TIME SETTING
- ⇒ REMOTE CONTROL PER 3G/LAN

NEW CLEANING SYSTEM
+30% EFFICIENCY

Standard equipment

- ◇ Control panel with black-lit lcd display
- ◇ Polyester cartridge filter
- ◇ Level sensor
- ◇ Exhaust valve product
- ◇ Sensor connector cable 10 mt

innovation for clean air

MODEL	Unit of measure	WX15
Electrical rated power	W	1500
Rated voltage	V	230
Rated frequency	Hz	50
Internal hopper capacity	lt	7
Max. vacuum rate	Mbar	275
Type of filter	/	Self-cleaning
Structure	material	carbon steel
Total weight	kg	24
Dimensions	mm	390 x H700
IN/OUT hoses Ø	mm	Ø 50

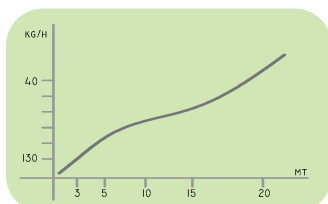
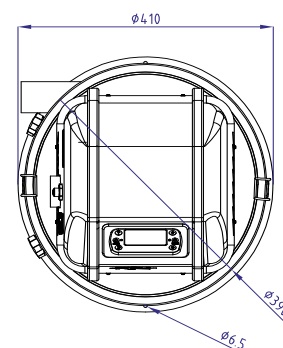
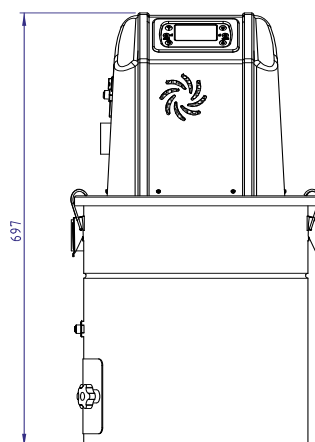

Accessories

	Suction Probe	ART NO
		PR0001

	Intermediate hopper	ART NO
		WX1005

	Suction probe from big-bag	ART NO
		PR3669

	Connection plate	ART NO
		PP0004

	Manual change over unit	ART NO
		PR0013

	Compression clamp	ART NO
		FS0001



PNEUMATIC CONVEYOR WX52BFR

The pneumatic conveyor model WX52 is the ideal solution to load granular biomass products at considerable distance with flow of fuel up to 500kg/h

- ⇒ IDEAL SOLUTION TO FEED PELLET STOVES AND BOILERS
- ⇒ AUTOMATIC OPERATION
- ⇒ ADAPTABLE TO ANY HEATING SYSTEM
- ⇒ CHRONO TIME SETTING
- ⇒ MOTOR PROTECTION THROUGH A SOFT START
- ⇒ IT WORKS 24H/24

Standard equipment

- ◆ Electrical display
- ◆ Self-cleaning filter cartridge
- ◆ Level Sensor
- ◆ Exhaust valve product
- ◆ Alimentation cable hopper 20 mt

Model	Unit of measure	WX52BFR	WX52BFR-T
Rated electrical power	kW	1,5	1,5
Rated voltage	V	230 (inverter)	380 (soft start)
Rated frequency	Hz	50	50
Internal hopper capacity	lt	6	6
Max vacuum rate	Mbar	275	250
Type of filter	/	Self-cleaning cartridge	
Pressure cleaning system	Air	6 bar	
Structure	material	carbon steel	
Total weight	kg	95	95
Motor dimension	mm	500x 500 x H 700	500x 500 x H 700
IN/OUT holes Ø	mm	Ø 50	Ø 50
Filtering base dimensions	mm	Ø 360 x H 1000	

experience and technology in

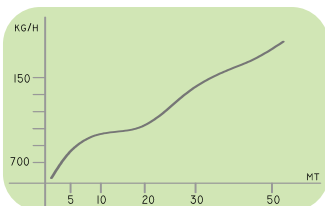
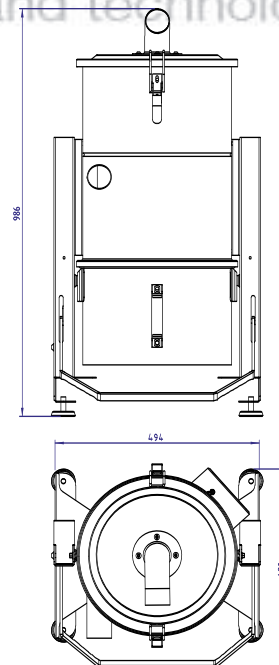
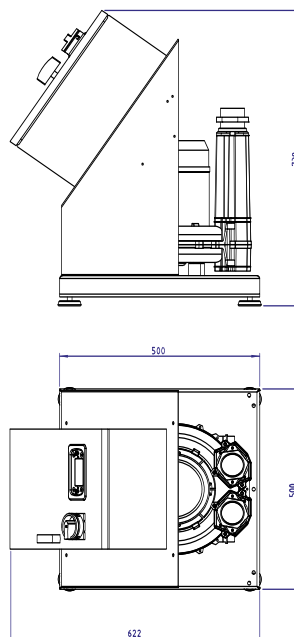

Accessories

	Suction probe	ART NO
		PR0001

	Flexible antistatic hose Ø 50 (min. order 20mt)	ART NO
		TB0001

	Compressor 6 lt	ART NO
		EINE01

	Fluidising	ART NO
		SL0001

	90° steel bend	ART NO
		CA5001

	Ash preseparator	ART NO
		PRC01



PNEUMATIC CONVEYOR WX52

The pneumatic conveyor model WX52 is the ideal solution to load granular biomass at considerable distance with flow of fuel up to 500kg/h

- ⇒ IDEAL SOLUTION TO FEED PELLET STOVES AND BOILERS
- ⇒ AUTOMATIC OPERATION
- ⇒ ADAPTABLE TO ANY HEATING SYSTEM
- ⇒ CHRONO TIME SETTING
- ⇒ MOTOR PROTECTION THROUGH SOFT START
- ⇒ IT WORKS 24H/24

Standard equipment

- ◇ Electrical display
- ◇ Self-cleaning filter cartridge
- ◇ Level sensor
- ◇ Exhaust valve product
- ◇ Alimentation cable sensor 20 mt

CLEANING SYSTEM
PULSE AIR-JET



INVERTER / SOFT START

IT WORKS 24H/24

INTERNAL CYCLON

MODEL	Unit of measure	WX52	WX52i
Rated electrical power	kW	1,5	2,2
Rated voltage	V	380 (soft start)	220 (inverter)
Rated frequency	Hz	50	50
Internal hopper capacity	lt	12	
Max vacuum rate	Mbar	250	275
Type of filter	/	Self-cleaning cartridge filter	
Pressure cleaning system	Air	6 bar	
Structure	material	Carbon steel	
Total weight	kg	95	97
Motor dimensions	mm	500x 500 x H 700	
IN/OUT hoses Ø	mm	Ø 60	
Hopper dimensions	mm	Ø 360 x H 1000	

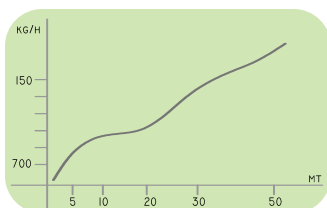
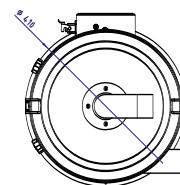
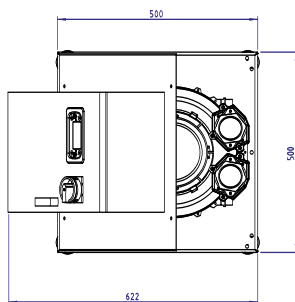
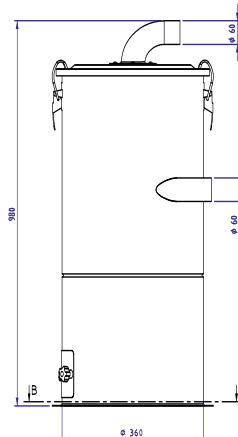
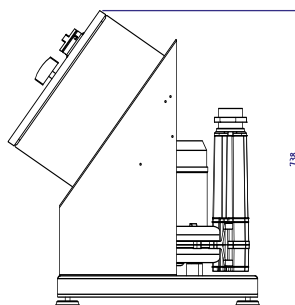

Accessories

	Remote control KIT LAN/3G	ART NO
		KTE3G

	Automatic changeover unit	ART NO
		SPAUT04

	Tracking preseparator 150lt	ART NO
		PRC15

	Compression clamp Ø50	ART NO
		FS0002

	Manual changeover unit	ART NO
		PR0013

	Internal hopper	ART NO
		WX1005



PNEUMATIC CONVEYOR WX55

The pneumatic conveyor model WX 55 is the ideal system to load granular biomass at considerable distance and with flow of fuel up to 1000kg/h

- ⇒ IDEAL SYSTEM TO FEED PELLET STOVES AND BOILERS
- ⇒ AUTOMATIC OPERATION
- ⇒ ADAPTABLE TO ANY HEATING SYSTEM
- ⇒ CHRONO TIME SETTING
- ⇒ MOTOR PROTECTION THROUGH SOFT START UP
- ⇒ IT WORKS 24H/24

Standard equipment

- ◆ Electrical panel installed on the base of the motor
- ◆ Self-cleaning cartridge filter
- ◆ Min/max level sensor
- ◆ Exhaust valve product
- ◆ Hopper alimentionation cable 20 mt
- ◆ Vacuum breaker

MODEL	Unit of measure	WX55	WX60i
Rated electrical power	kW	3	4
Rated voltage	V	380	
Rated frequency	Hz	50	
Internal hopper capacity	lt	12	
Max vacuum rate	Mbar	275	325
Type of filter	/	Self-cleaning cartridge filter	
Cleaning system alimentionation	Air	6 bar	
Structure	Material	Carbon steel	
Total weight	kg	105	107
Motor dimensions	mm	600x 600 x H 1300	600x 600 x H 1300
IN/OUT hoses Ø	mm	Ø 60	
Hopper dimensions	mm	Ø 360 x H 1000	

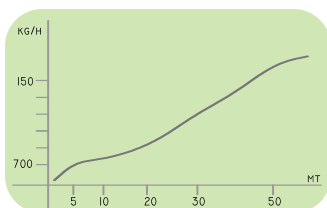
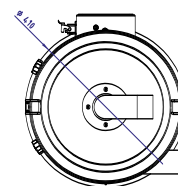
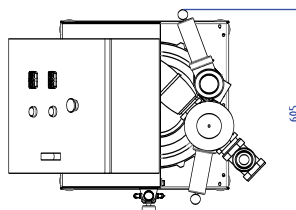
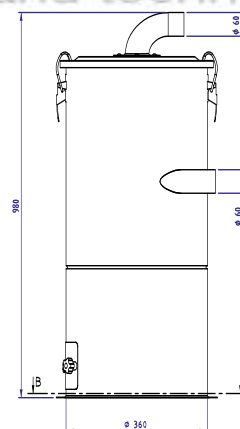
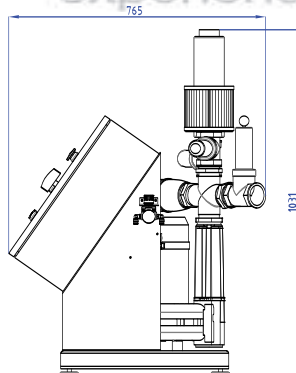

Accessories

	pipe reduction from Ø60 to Ø 50	ART NO
		RI0050

	Emptying hose valve	ART NO
		VLS001

	galvanized steel pipe Ø 50	ART NO
		TB0002

	Deviating valve type y 2 pellet line	ART NO
		VAY-P

	bend steel 90°	ART NO
		CA5001

	Deviating valve type y 2 return air line	ART NO
		VAY-V



STEEL STORAGE SILO

The storage tank SUM is the ideal solution for all pneumatic extraction systems

- ⇒ QUICK CONNECTION TO SUCTION PROBE
- ⇒ BUILT IN GALVANIZED STEEL
- ⇒ ADAPTABLE TO ANY SUCTION SYSTEM
- ⇒ MANUAL FILLING WITH BAGS/ PROTECTION GREED

Standard equipment

- ◇ Suction probe with extension door
- ◇ bolts kit



innovation for clean air

ART NO	Volume (m ³)	Weight (kg)	Height A (cm)	Dimensions BxC (cm)	Extraction system
SL0001M	1	650	140	103x103	pneumatic
SL0001M	1	650	140	103x103	screw (0,18kw)
SL0015M	1.5	975	190	103x103	pneumatic
SL0015M	1.5	975	190	103x103	screw (0,18kw)
SL0003M	3	1950	190	103x206	pneumatic
SL0003M	3	1950	190	103x206	screw (0,18kw)

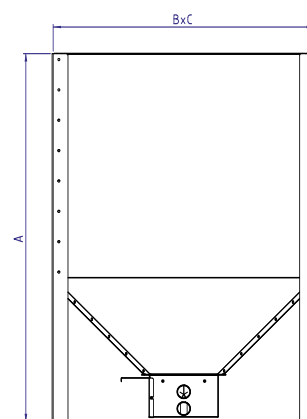

SL0003M with kit for loading from tanker

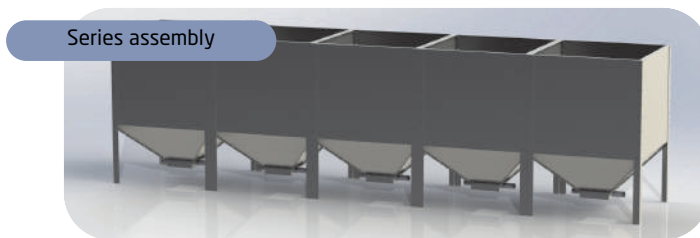

Series assembly

Accessories

	Pneumatic extraction module	ART NO
		PR00ES

	Silo extension module 0,5 m ³	ART NO
		ES0050

	Pneumatic extraction module with screw	Articolo n°
		CE00WX

	Safety greed	ART NO
		GR0001

	Kit for loading from tanker (for SL0001M)	ART NO
		KITSUM1

	Kit for loading from tanker (for SL0003M)	ART NO
		KITSUM2



Fabric filtering roof

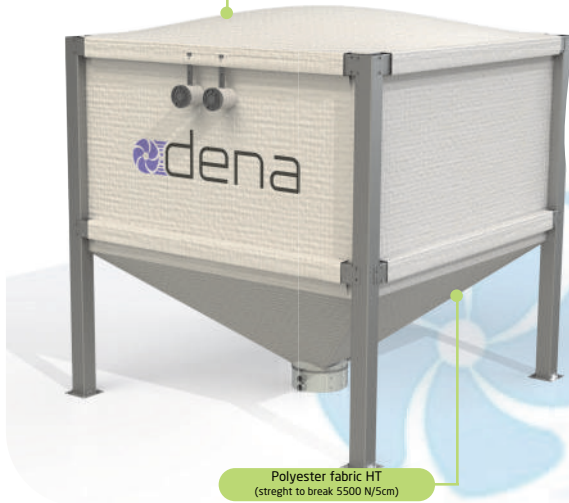

Polyester fabric HT
(streight to break 5500 N/5cm)

FABRIC STORAGE SILO

The silo for pellet model SIT, is a professional silo compatible with all systems of pneumatic extraction, the ideal solution for storage rooms and indoor places. It can be equipped with extraction unit through pneumatic or motorized screw.

- ⇒ GALVANIZED STEEL FRAME/ QUICK CONNECTION TO SUCTION PROBE
- ⇒ ADAPTABLE TO ANY KIND OF WX SUCTION SYSTEM
- ⇒ FILLING THROUGH FUEL FILLER STORZ TYPE
- ⇒ ANTISTATIC, HIGH RESISTANT POLYESTER FABRIC 355 gr/m²
- ⇒ IT IS PROVIDED IN PACKAGED PIECES/ QUICK ASSEMBLY

Standard equipment

- ◇ Opening with manual loading
- ◇ Bolts kit
- ◇ Fuel filler for quick filling storz 4" type

ART NO	Volume (m ³)	Weight (ton)	Height A (cm)	Dimensions BxC (cm)	Height D (cm)	Extraction system
SIT5	5.3	3.2	220	214x214	225	pneumatic
SIT5-C	5.3	3.2	220	214x214	225	screw (0,18kw)
SIT8	6.7	4	230	240x240	235	pneumatic
SIT8-C	6.7	4	230	240x240	235	screw(0,18kw)
SIT10	10	6	250	250x250	255	pneumatic
SIT10-C	10	6	250	250x250	255	screw (0,18kw)

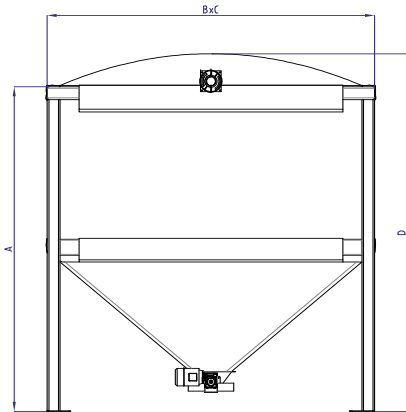

Silos up to 30 m³ are available to request

Accessories

	Pneumatic extraction module	ART NO
		PR12ES

	Plug for fuel filler	ART NO
		BR00ST

	extraction module with screw	ART NO
		CE00WX

	Fuel filler for quick filling storz 4" type	ART NO
		BR0004

	Bend steel 90°	ART NO
		CA5001

	Compression clamp	ART NO
		FS0001



JOINT PANELS
QUICK AND EASY ASSEMBLY

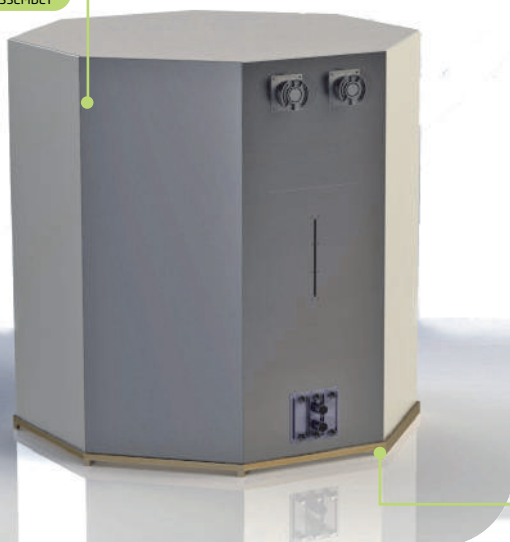

MULTILAYER WOOD
ANTI-HUMIDITY



OCTAGONAL STEEL STORAGE SILO

The storage silo ESA model, is a professional silo compatible with all pneumatic extraction systems. It is the ideal solution for storage rooms and indoor places.

- ⇒ QUICK CONNECTION TO SUCTION PROBE/ BUILT IN GALVANIZED STEEL
- ⇒ ADAPTABLE TO ANY KIND OF SUCTION SYSTEM
- ⇒ FILLING THROUGH FUEL FILLER STORZ TYPE
- ⇒ MANUAL CHANGEOVER UNIT
- ⇒ IT IS SUPPLIED IN PREASSEMBLED PIECES
- ⇒ VERY QUICK AND EASY TO ASSEMBLE
- ⇒ MANUAL LOADING DOOR

innovation for clean air

ART NO	Volume (m ³)	Weight (ton)	Height A (cm)	Dimensions Ø B (cm)	Extraction systems
ESA160-16	2.6	1.56	165	160 (8 lati)	NO 3 suction probes
ESA160-19	3	1.8	195	160 (8 lati)	NO 3 suction probes
ESA200-16	4.3	2.58	165	200 (8 lati)	NO 3 suction probes
ESA200-19	5	3	195	200 (8 lati)	NO 3 suction probes
ESA250-16	6.9	4.14	165	250 (10 lati)	NO 3 suction probes
ESA250-19	8	4.8	195	250 (10 lati)	NO 3 suction probes

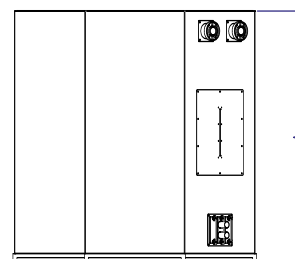

The complete series

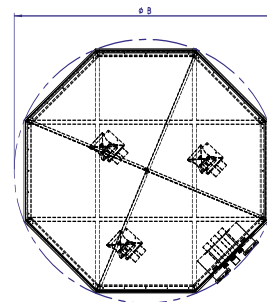

Accessories

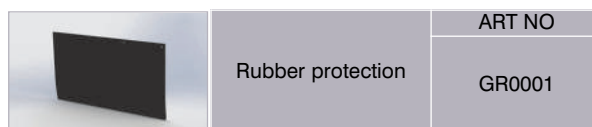
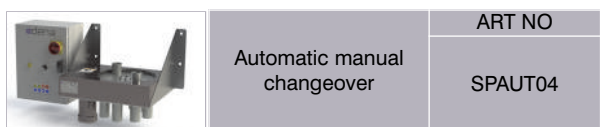
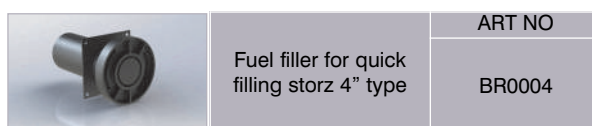
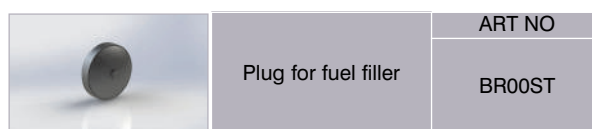



SPARE PARTS

	Single phase motor	ART NO
		MBP015

	Cartridge filter WX52 / BFR	ART NO
		CAR218H26

	Solenoid valve	ART NO
		ELE001

	Inductive sensor	ART NO
		SENSO1

	Motor brushes kit	ART NO
		MSP015

	Lcd control panel	ART NO
		CEQ001

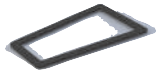
	Seal for hopper WX5	Articolo n°
		GRZ005

	Seal for hopper WX10-10C-15-52	ART NO
		GRZ010

	Filtering cartridge WX11	Articolo n°
		WX11-FPC

DENA ASPIRAZIONI INDUSTRIALI

Sede legale:

Via Del Mancino, 106 Lanciano (CH) - ITALY

+39.0872.320.134

www.denaspirazioni.com info@denaspirazioni.com



dena

experience and technology innovation for clean air